

BOVELACCI



Dott. Ing. Bovelacci Marco 2008



ITALSTYL

- ① LE CORNICI ESTRUSE IN POLISTIRENE
- Ⓒ POLYSTYRENE EXTRUDED MOULDINGS
- Ⓓ EXTRUDIERTER ZIERPROFILE AUS POLYSTYROL
- Ⓕ CORNICHES EN POLYSTYRÈNE EXTRUDÉ



ITALSTYL 701, 779,
PROFILSTYL B110 BIANCO,
WOODSTYL TM16 H.Q. ROVERE

BOVELACCI



BOVELACCI

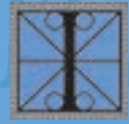

ITALSTYL

-  LE CORNICI ESTRUSE IN POLISTIRENE
-  POLYSTYRENE EXTRUDED MOULDINGS
-  EXTRUDIERTER ZIERPROFILE AUS POLYSTYROL
-  CORNICHES EN POLYSTYRÈNE EXTRUDÉ
-  MOLDURAS EXTRUDIDAS DE POLIESTIRENO
-  SANCAS EM POLISTIRENO EXTRUDIDO
-  PS-GEËXTRUDEERD SIERPROFIELEN
-  ΚΟΡΝΙΖΕΣ ΕΞΗΛΑΣΜΕΝΗΣ ΠΟΛΥΣΤΕΡΙΝΗΣ
-  EKSTRÜDE POLISTREN KARTONPIYER
-  EXTRUDERADE POLYSTYREN LISTER
-  PROFILERTE POLYSTYRENE LISTER
-  STUKLISTER AF EKSTRUDEREDE POLYSTYREN
-  STYROKSILISTAT
-  EKSTRUDIRANE OKRASNE PROFILE IZ POLISTIRENA
-  EKSTRUDIRANI POLISTIREN PROFILI
-  ПЛИНТУСА ЭКСТРУДИРОВАННЫЕ
-  LISTWY EKSTRUDOWANE
-  LIŠTY POLYSTYREN EXTRUDOVANÝ
-  CORNISE DIN POLISTIREN EXTRUZ
-  EXTRUDÁLT DÍSZLÉCEK
-  ПЛИНТУС ЕКСТРУДИРОВАНИИ
-  ЕКСТРУДИРАНИ ПРОФИЛИ
-  聚苯乙烯的装饰
-  ポリスチロール製飾り縁(押し出し成形)

CORNICI ESTRUSE IN POLISTIRENE
EXTRUDED PS MOULDINGS

BOVELACCI

I
**LE CORNICI
 ESTRUSE
 PER SOFFITTI**

Cornici in polistirene estruso
 Lunghezza: 2 ml per asta

Angoli in polistirene espanso:
 Angoli Interni
 Angoli esterni

GB
**EXTRUDED
 CEILINGS
 MOULDINGS**

Extruded ceilings mouldings
 Length: 2 lm (78 3/4")

Expanded PS corner blocks:
 Inside corner blocks
 Outside corner blocks

D
**EXTRUDIERTER
 LINEARE
 ECKLEISTEN**

Extrudierte Zierprofile aus Polystyrol
 Länge: 2 Meter

Ecken aus expandiertem PS:
 Innenecken
 Aussenecken

F
**CORNICHES
 EXTRUDÉS
 POUR PLAFOND**

Corniches en polystyrène extrudé
 Longueur: 2 mètres

Angles en polystyrène expansé:
 Angles rentrants
 Angles sortants



IA725I

IA725E



IA735I

IA735E



IA755I

IA755E



IA785I

IA785E

IA741I



IA741E

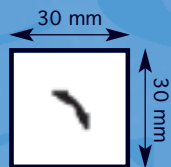

I 741



1 1/8" x 1 1/8"

IA743I



IA743E

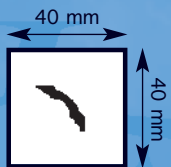

I 743



1 5/8" x 1 5/8"

IA750I



IA750E



I 750



2" x 2"

IA778I



IA778E

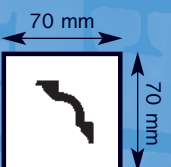

I 778



2 3/4" x 2 3/4"

IA780I



IA780E

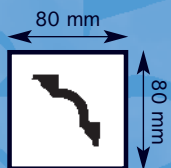

I 780



3 1/8" x 3 1/8"

IA790I



IA790E

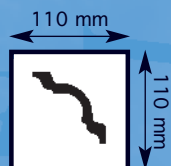

I 790



4 3/8" x 4 3/8"

Lunghezza: 2 ml per asta

Length: 2 lm (78 3/4")

Länge: 2 Meter

Longueur: 2 mètres



IA715I

IA715E

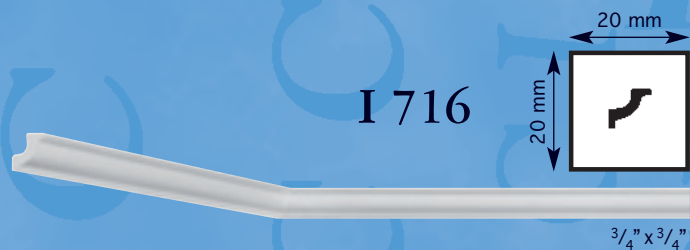

EUROCOLL

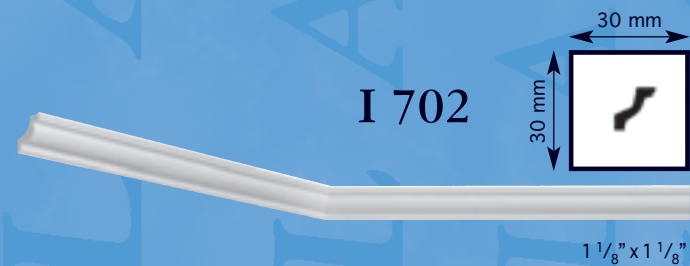

IA702I

IA702E



IA703I

IA703E



* Indicato anche per illuminazione
fredda indiretta

* Suitable also for indirect
cold lighting

* Geeignet für indirekte kalte
Beleuchtungen

* Convient pour l'éclairage
indirect froid

IA742I



IA742E



I 742

$1\frac{1}{8}'' \times 1\frac{3}{8}''$

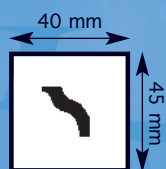

I 760

IA760I



IA760E



$1\frac{5}{8}'' \times 1\frac{3}{4}''$

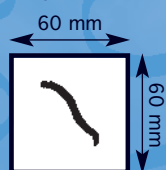

I 758

IA758I



IA758E



$2\frac{3}{8}'' \times 2\frac{3}{8}''$

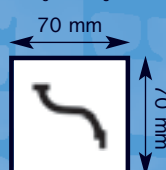

I 761

IA761I



IA761E



$2\frac{3}{4}'' \times 2\frac{3}{4}''$

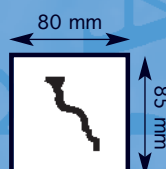

I 763

IA763I



IA763E



$3\frac{1}{8}'' \times 3\frac{3}{8}''$

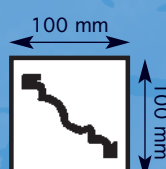

I 764*



$3\frac{7}{8}'' \times 3\frac{7}{8}''$

Lunghezza: 2 ml per asta

Length: 2 lm (78 $\frac{3}{4}$ ")

Länge: 2 Meter

Longueur: 2 mètres



I 720

20 mm

25 mm

3/4" x 1"

IA720I

IA720E

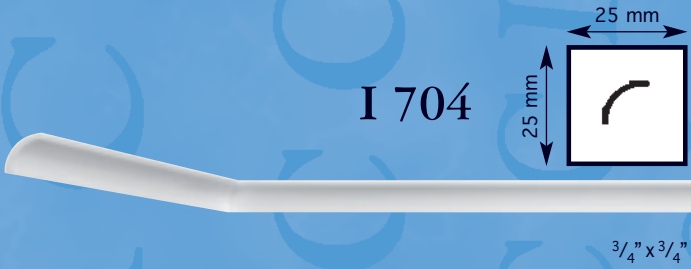

I 704

25 mm

25 mm

3/4" x 3/4"

IA704I

IA704E



I 705

35 mm

35 mm

1 3/8" x 1 3/8"

IA705I

IA705E



I 706

50 mm

50 mm

2" x 2"

IA706I

IA706E



I 762

60 mm

60 mm

2 3/8" x 2 3/8"

IA762I

IA762E

IA766I



IA766E

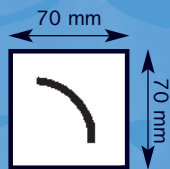

I 766

$2\frac{3}{4}'' \times 2\frac{3}{4}''$



IA767I



IA767E

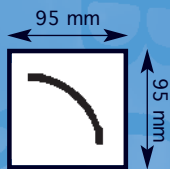

I 767

$3\frac{3}{4}'' \times 3\frac{3}{4}''$



IA747I



IA747E

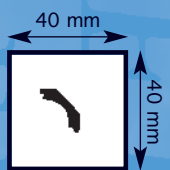

I 747

$1\frac{5}{8}'' \times 1\frac{5}{8}''$

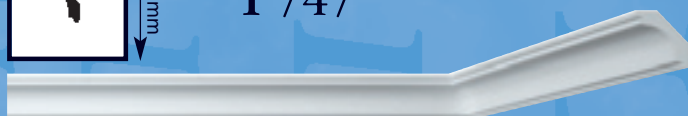

IA707I



IA707E



I 707

2'' x 2''



IA765I



IA765E

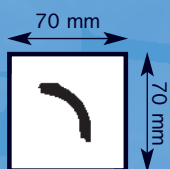

I 765

$2\frac{3}{4}'' \times 2\frac{3}{4}''$



Lunghezza: 2 ml per asta

Length: 2 lm ($78\frac{3}{4}''$)

Länge: 2 Meter

Longueur: 2 mètres



IA775I

IA775E



IA777I

IA777E



IA793I

IA793E



IA795I

IA795E



* Indicato anche per illuminazione
fredda indiretta

* Suitable also for indirect
cold lighting

* Geeignet für indirekte kalte
Beleuchtungen

* Convient pour l'éclairage
indirect froid

IA737I



IA737E

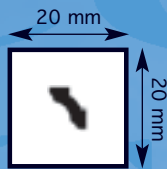

I 737

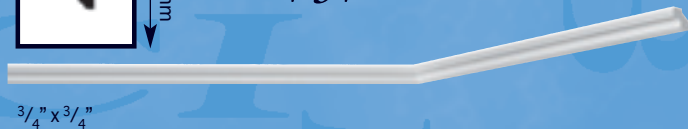

IA740I



IA740E

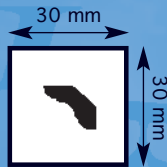

I 740



IA717I



IA717E

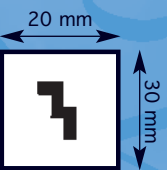

I 717



IA779I



IA779E

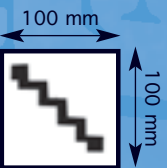

I 779

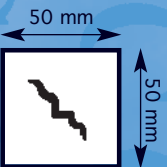

I 732

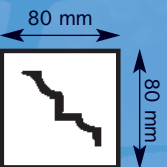

I 734



IL DISPLAY ITALSTYL

I
LE CORNICI ESTRUSE
E GLI ANGOLI PER
PARETI E SOFFITTI

Lunghezza: 2 ml per asta
Cornici in polistirene estruso
Angoli in polistirene espanso

GB
EXTRUDED PANEL
MOULDINGS
WITH CORNERS

Length: 2 lm (78 3/4")
Extruded panel mouldings
Expanded PS corner blocks

D
EXTRUDIERTE
WANDLEISTEN
UND BÖGEN

Länge: 2 Meter
Extrudierte Zierprofile aus Polystyrol
Bögen aus expandiertem PS

F
CORNICHES EXTRUDÉS
ET ANGLES POUR
MURS ET PLAFONDS

Longueur: 2 mètres
Corniches en polystyrène extrudé
Angles en polystyrène expansé

<p>I 709</p> <p>14 mm 40 mm 1 5/8" x 1 1/2"</p>	<p>IA709LP 14,5 x 14,5 - r. 8 cm (5 3/4" x 5 3/4" - r. 3 1/8")</p>	<p>IA709LG 20,5 x 20,5 - r. 12,5 cm (8 1/8" x 8 1/8" - r. 4 7/8")</p>	<p>IA709D 20,5 x 20,5 (8 1/8" x 8 1/8")</p>
<p>I 745</p> <p>17 mm 40 mm 1 5/8" x 5/8"</p>	<p>IA745LP 15 x 15 - r. 8 cm (5 7/8" x 5 7/8" - r. 3 1/8")</p>	<p>IA745LG 20 x 20 - r. 12,5 cm (7 7/8" x 7 7/8" - r. 4 7/8")</p>	<p>IA745D 20 x 20 (7 7/8" x 7 7/8")</p>
<p>I 770</p> <p>14 mm 70 mm 2 3/4" x 1 1/2"</p>	<p>IA770LP 15 x 15 - r. 8 cm (5 7/8" x 5 7/8" - r. 3 1/8")</p>	<p>IA770LG 22,5 x 22,5 - r. 15 cm (8 7/8" x 8 7/8" - r. 5 7/8")</p>	<p>IA770D 22 x 22 (8 5/8" x 8 5/8")</p>
<p>I 710</p> <p>14 mm 70 mm 2 3/4" x 1 1/2"</p>	<p>IA710LP 15 x 15 - r. 8 cm (7 1/8" x 5 7/8" - r. 3 1/8")</p>	<p>IA710LG 20 x 20 - r. 12,5 cm (7 7/8" x 7 7/8" - r. 4 7/8")</p>	<p>IA710D 22 x 22 (8 5/8" x 8 5/8")</p>
<p>I 701</p> <p>8 mm 60 mm 2 3/8" x 3/8"</p>	<p>IA701LP 14 x 14 - r. 6 cm (5 1/2" x 5 1/2" - r. 2 3/8")</p>	<p>IA701LG 20 x 20 - r. 12,5 cm (7 7/8" x 7 7/8" - r. 4 7/8")</p>	<p>IA701D 20 x 20 (8 5/8" x 8 5/8")</p>

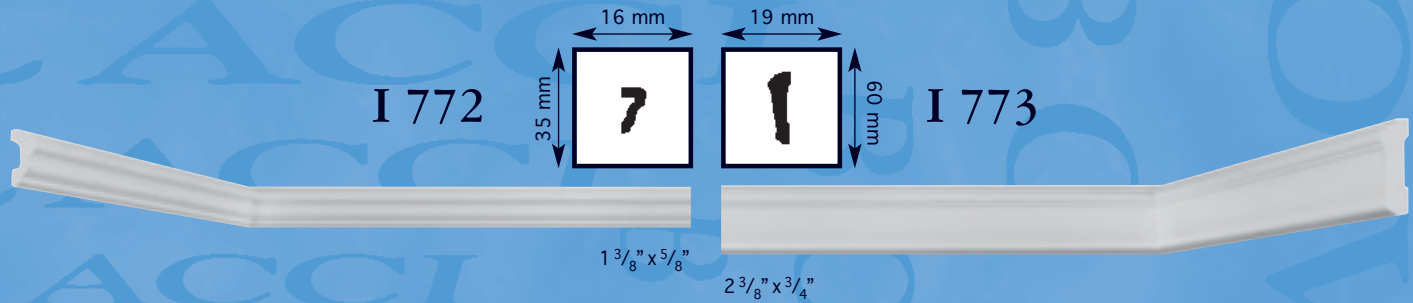
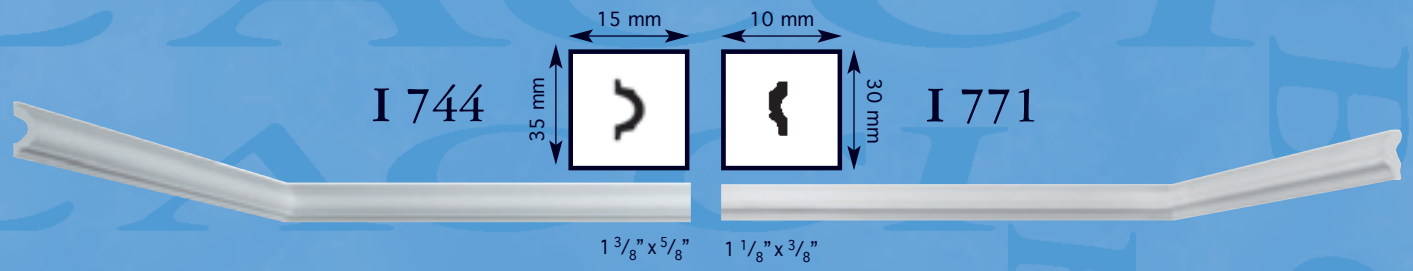

mlt 310 - Kg 7 - Kg 1,8





IA801LP

14x14 - r. 6 cm

(5 8/16" x 5 8/16" - r. 2 6/16")

IA801LG

20x20 - r. 12,5 cm

(7 14/16" x 7 14/16" - r. 4 15/16")

IA801D

20x20 cm

(7 14/16" x 7 14/16")

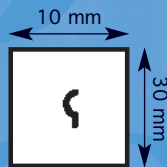

I 801

1 1/8" x 3 3/8"

IF802DC

15,5x6,5 cm

(6 2/16" x 2 9/16")



IF802DF

15,5x6,5 cm

(6 2/16" x 2 9/16")

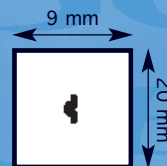

I 802

13/16" x 6 1/16"



IT802

6x6 - r. 6 cm

(2 6/16" x 2 6/16" - r. 2 6/16")

IA802LG

18,5x18,5 - r. 9 cm

(7 5/16" x 7 5/16" - r. 3 9/16")



IA802LM

15,5x15,5 - r. 8,5 cm

(6 2/16" x 6 2/16" - r. 3 6/16")



IA802LP

8x8 - r. 4 cm

(2 2/16" x 3 2/16" - r. 1 9/16")



IA802DG

15,5x15,5 cm

(6 2/16" x 6 2/16")



IA802DP

12x12 cm

(4 12/16" x 4 12/16")

IF803DC

15,5x7 cm

(6 2/16" x 2 12/16")



IF803DF

15,5x6,5 cm

(6 2/16" x 2 9/16")

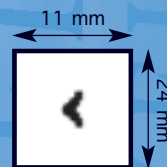

I 803

15/16" x 7 1/16"



IT803

9x9 - r. 9 cm

(3 9/16" x 3 9/16" - r. 3 9/16")

IA803LG

20x20 - r. 11,5 cm

(7 14/16" x 7 14/16" - r. 4 8/16")



IA803LM

15,5x15,5 - r. 8,5 cm

(6 2/16" x 6 2/16" - r. 3 6/16")



IA803LP

10,5x10,5 - r. 5 cm

(4 2/16" x 4 2/16" - r. 1 15/16")



IA803DG

15,5x15,5 cm

(6 2/16" x 6 2/16")



IA803DP

10,5x10,5 cm

(4 2/16" x 4 2/16")



RF803/52DG

L.43 x p. 3,5 x H. 36 cm

(1/4 di cerchio ø 52 cm)

(L. 16 15/16" x d. 1 6/16" x H. 14 3/16")



RF803/52DP

L.43 x p. 4 x H. 23,5 cm

(1/4 di cerchio ø 52 cm)

(L. 16 15/16" x d. 1 9/16" x H. 9 4/16")



RF803/52L

L. 40 x H. 10

(1/4 di cerchio ø 52 cm)

(L. 15 12/16" x H. 3 15/16")

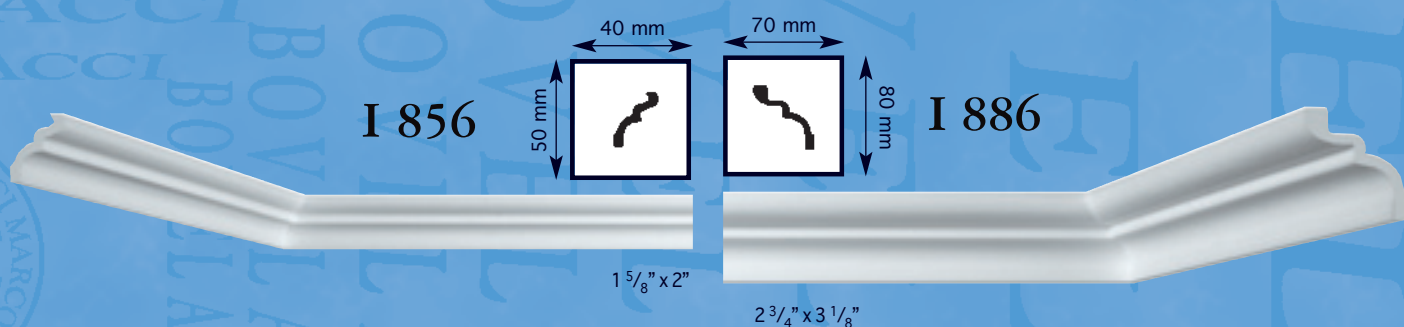
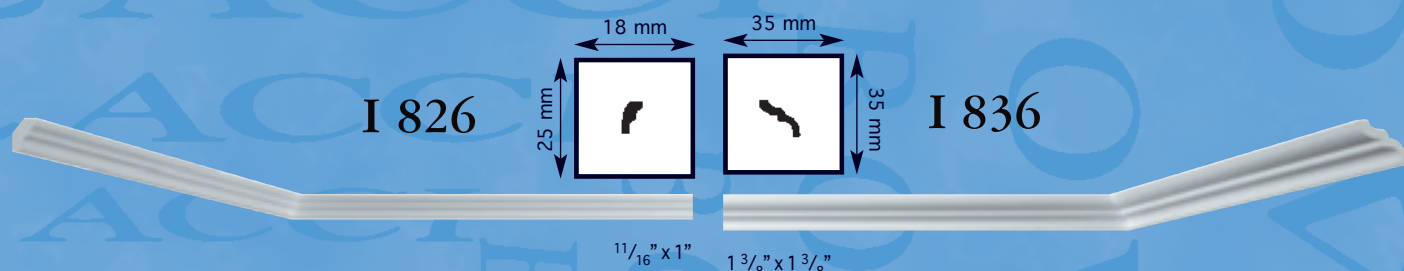
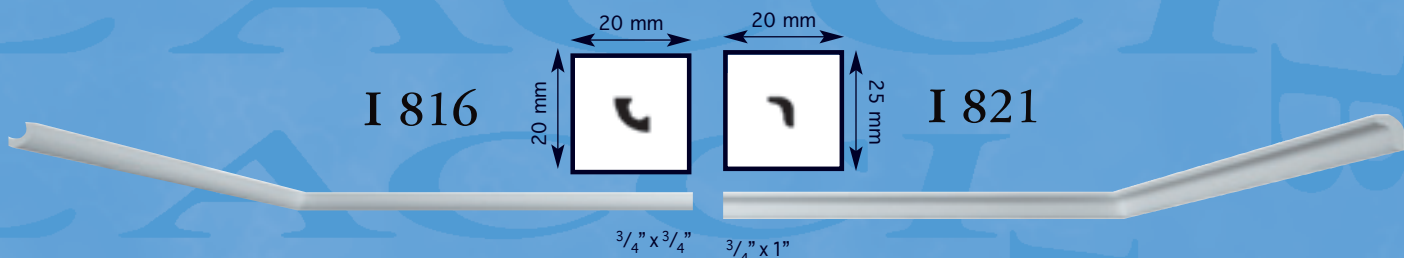

Lunghezza: 2 ml per asta

Length: 2 lm (78 3/4")

Länge: 2 Meter

Longueur: 2 mètres

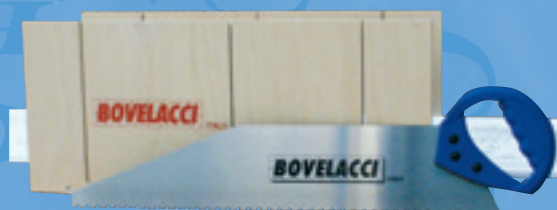

LA SEGA SPECIALE

L. 50 cm

SPECIAL SAW

L. 50 cm

SPEZIALSÄGE

L. 50 cm

SCIE SPÉCIAL

L. 50 cm

LA CASSETTA PER TAGLIO

Dim. int. 16 x 20 x L. 50 cm

MITRE-BOX

Internal Dim. 16 x 20 x L. 50 cm

GEHRUNGSLADE

Arbeitsmaße: 16 x 20 x L. 50 cm

BOITE À ONGLET

Dim. int. 16 x 20 x L. 50 cm

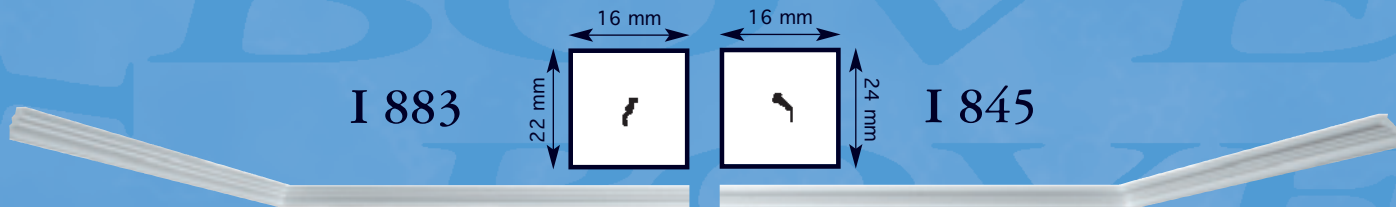

I 883

I 845

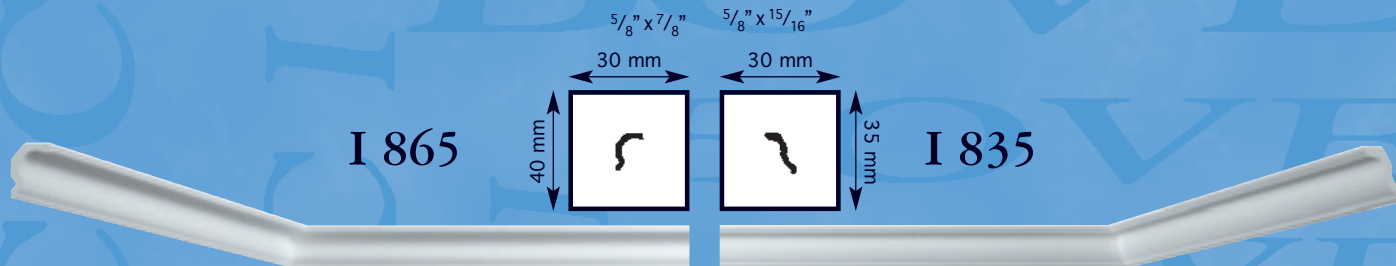

I 865

I 835

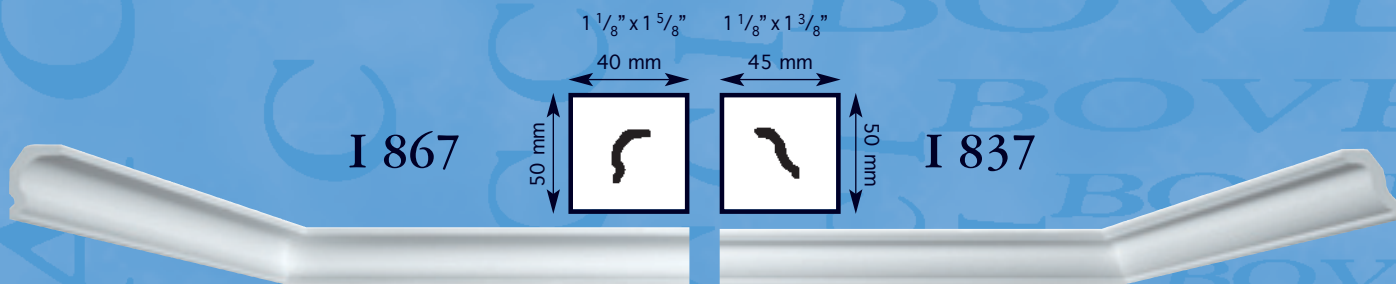

I 867

I 837



IL DISPLAY
LA SERIE 800

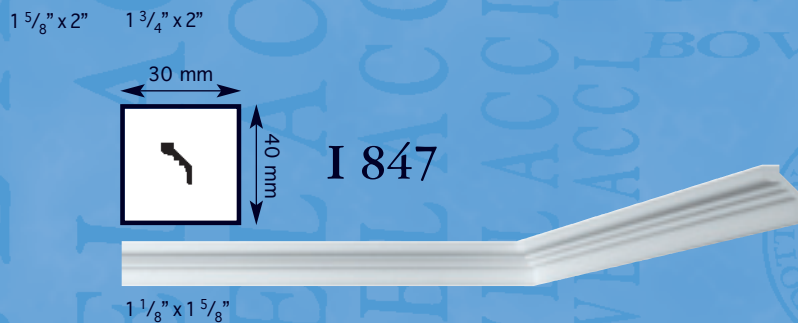

I 847

$1\frac{1}{8}'' \times 1\frac{5}{8}''$

EUROCOLL



mlt 310 - Kg 7 - Kg 1,8

Collante speciale per polistirene in pasta bianca (incidenza media: 1 cart. x 10 ml)
 Temperatura di applicazione: +8 °C ÷ +30 °C
 Temperatura d'impiego ad essiccazione avvenuta: +0 °C ÷ +55 °C
 Conservazione: 10 mesi
 Teme il gelo
 Lasciare asciugare per una settimana, poi stuccare con Eurocoll e rifinire con una vernice a base d'acqua
 Prima del montaggio si consiglia di testare la colla sul sottofondo

Special adhesive for polystyrene white paste (average incidence: 1 cart. x 10 ml)
 Application temperature: +8 °C ÷ +30 °C
 Temperature stability +0 °C ÷ +55 °C
 Shelf life: 10 months
 Keep away from chill
 Let dry for a week, before filling up the joints with Eurocoll and finishing with water-based paint
 Testing glue before applying is recommended

Spezial-Klebstoff für Polystyrol, weiss, p astös (durchschnittlicher Verbrauch: 1 Kart. x 10 ml)
 Verarbeitungstemperatur: +8 °C ÷ +30 °C
 Temperaturbeständigkeit: +0 °C ÷ +55 °C
 Lagerstabilität: 10 Monate
 Nach einer Trocknungszeit von einer Woche können die Fügen mit Eurocoll gefüllt werden und mit Dispersionsfarbe oder Acryllack überstrichen werden
 Vor der Montage testen Sie bitte mit einem kl. Musterstück die Festigkeit des Klebers auf dem Untergrund

Colle spéciale pour polystyrène en pâte blanche (incidence moyenne: 1 cart. x 10 ml)
 Température d'application: +8°C à +30°C
 Température de stabilité: 0°C à +55°C
 Durée de conversation: 10 mois
 Conserver à l'abri du gel
 Laissez sécher une semaine avant de remplir les joints de colles et de peindre avec une peinture acrylique
 Un test de la colle est recommandé avant son, utilisation

①

**I NASI UNIVERSALI
PER SOFFITTI**

consigliati per cornici Italstyl:

mm 30x30: 702, 704, 715, 716, 717, 720, 725, 737, 740, 741, 816, 821, 826, 845



ENLP30I

dim=mm 30x30 L=cm 4x4



ENDP30I

dim=mm 30x30 L=cm 4x4

Ⓒ

**UNIVERSAL
CORNER BLOCKS**

for Italstyl mouldings:

Ⓓ

**UNIVERSELLE
ECKEN**

für Eckleisten Italstyl:

Ⓕ

**ANGLES UNIVERSELS
POUR PLAFOND**

pour corniches Italstyl:



ENLP30C

dim=mm 30x30 L=cm 3,5



ENDP30C

dim=mm 30x30 L=cm 3,5



ENLP30E

dim=mm 30x30 L=cm 4x4



ENDP30E

dim=mm 30x30 L=cm 4x4

consigliati per cornici Italstyl:

for Italstyl mouldings:

für Eckleisten Italstyl:

pour corniches Italstyl:

mm 50x50: 703, 705, 706, 707, 732, 735, 742, 750, 755, 760, 835, 836, 837, 856, 865, 867



ENLM50I

dim=mm 50x50 L=cm 7x7



ENDM50I

dim=mm 50x50 L=cm 7x7



ENLM50C

dim=mm 50x50 L=cm 5,5



ENDM50C

dim=mm 50x50 L=cm 5,5



ENLM50E

dim=mm 50x50 L=cm 7x7



ENDM50E

dim=mm 50x50 L=cm 7x7

consigliati per cornici Italstyl:

for Italstyl mouldings:

für Eckleisten Italstyl:

pour corniches Italstyl:

mm 80x80: 734, 758, 761, 762, 765, 766, 778, 780, 785, 886

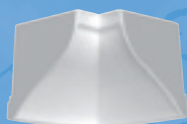

ENLG80I

dim=mm 80x80 L=cm 10,5x10,5

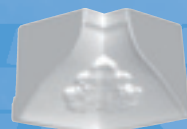

ENDG80I

dim=mm 80x80 L=cm 10,5x10,5



ENLG80C

dim=mm 80x80 L=cm 8,5



ENDG80C

dim=mm 80x80 L=cm 8,5

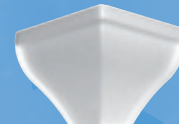

ENLG80E

dim=mm 80x80 L=cm 10,5x10,5



ENDG80E

dim=mm 80x80 L=cm 10,5x10,5

consigliati per cornici Italstyl:

for Italstyl mouldings:

für Eckleisten Italstyl:

pour corniches Italstyl:

mm 110x110: 763, 764, 767, 775, 776, 777, 779, 780

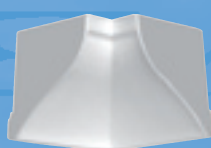

ENLXG110I

dim=mm 110x110 L=cm 13,5x13,5

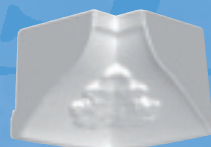

ENDXG110I

dim=mm 110x110 L=cm 13,5x13,5



ENLXG110C

dim=mm 110x110 L=cm 11,5



ENDXG110C

dim=mm 110x110 L=cm 11,5



ENLXG110E

dim=mm 110x110 L=cm 13,5x13,5



ENDXG110E

dim=mm 110x110 L=cm 13,5x13,5

①
LE ISTRUZIONI
PER IL MONTAGGIO

②
ASSEMBLING
INSTRUCTIONS

③
VERARBEITUNGS-
TIPS

④
INSTRUCTION
DE MONTAGE



EUROCOLL



mlt 310 - Kg 7 - Kg 1,8

È preferibile posare le cornici, gli angoli ed i rosoni prima di tappezzare le pareti. I prodotti devono essere applicati su pareti asciutte, pulite e sgrassate.

We suggest to install mouldings, corners and roses before wallpaping. Items must be applied on dry clean and ungreased surfaces.

Wir empfehlen die Zierprofile, Ecken, Rosetten nach Möglichkeit vor den Tapezierarbeiten zu verkleben. Der Untergrund muss saugfähig, sauber, trocken und staubfrei sein.

C'est préférable poser les corniches, angles et les rosaces avant de tapisser les parois. Les produits doivent être appliqués sur parois sèches propres et dégraissées.

Sono sufficienti i seguenti accessori: cassetta per taglio, sega speciale, Eurocoll, spatola, spugna, pittura, pennelli, cutter e metro.

You need only the following tools: mitre-box, special saw, glue Eurocoll, spatula, sponge, paint, brush, cutter and metre.

Folgende Werkzeuge werden benötigt: Gehrungslade, BOVELACCI-Spezialsäge, Eurocoll-Klebstoff, Spachtel, Schwamm, Pinsel, Cuttermesser und ein Zollstock.

Les suivants accessoires sont suffisants: caissette pour coupe, scie spécial, Eurocoll, spatule, éponge, peinture, pinceaux, cutter et mètre.

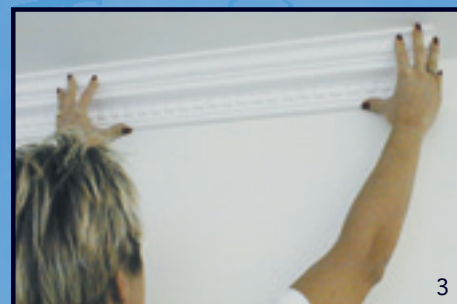
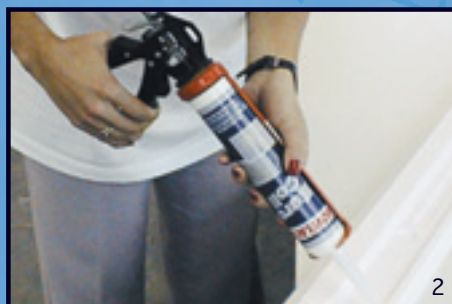

1. Iniziare a tagliare le cornici in modo da realizzare gli angoli che vi servono. Controllate che combininino.

1. Cut straight ends to make the type of corners you need. Check fit.

1. Beim Schneiden der Gehrung ist unbedingt darauf zu achten, dass die "Deckenklebefläche" des Zierprofils auf dem Boden und die "Wandklebefläche" an der Innenwand der Gehrungslade liegt.

1. Commencer à couper les corniches et réaliser les angles désirés. Vérifier le point de jonction.

2. Stendere la colla speciale Eurocoll su entrambe le superfici posteriori dell'asta che andranno a contatto con la parete o il soffitto, nonchè fra le giunture (incidenza media: 1 cart. x 10 ml).

2. Apply the special glue Eurocoll on both back surfaces of the stick meant to lean on the wall and inside the joint (average incidence: 1 cart. x 10 ml).

2. Nachdem die Gehrung auf Passgenauigkeit geprüft wurde, wird der Klebstoff auf beide Klebeflächen und im Stoßbereich mit der Kartusche oder mit dem Spachtel aufgetragen (durchschnittlicher Verbrauch: 1 Kart. x 10 ml).

2. Appliquer la colle spéciale Eurocoll sur tous les surfaces postérieures de la corniche au contact avec la paroi ou le plafond et entre les jointures (incidence moyenne: 1 cart. x 10 ml).

3. Applicare la cornice alla parete con una leggera pressione. Dopo una settimana riempite con la colla Eurocoll ogni giuntura o spazio.

3. Press pieces into the corner with a light pressure. After a week fill all joints and gaps with Eurocoll glue.

3. Das Zierprofil passgenau ansetzen und vorsichtig andrücken. Nach einer Woche alle Fugen und Stöße mit Eurocoll-Klebstoff füllen.

3. Appliquer la corniche à la paroi avec une légère pression. Après une semaine remplir avec la colle Eurocoll chaque jointure ou espace.

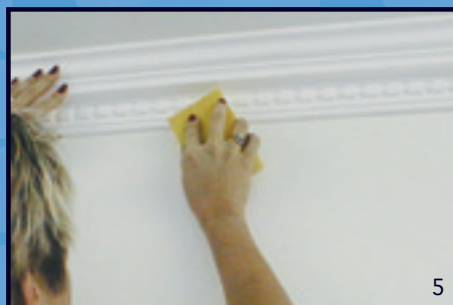

4. Togliete l'eccesso di colla con l'aiuto di una spatola.

4. Remove glue in excess by using a spatula.

4. Überschüssigen Klebstoff mit einem Spachtel sofort entfernen.

4. Enlever avec une spatule l'excès de colle.

5. Pulite quindi con l'aiuto di una spugna.

5. Wipe smooth with a clean damp sponge.

5. Anschließend Klebstoffreste mit einem feuchten Schwamm sofort abwaschen.

5. Nettoyer avec une éponge.

6. Lasciate asciugare e rifinite con vernice a base d'acqua.

6. Let dry and apply water-based paint.

6. Die Zierprofile können nach einer Trocknungszeit von ca. 24 Std. mit Dispersionsfarbe oder Acryllack überstrichen werden.

6. Laisser essuyer et puis peindre avec peinture à base d'eau.



I ITALSTYL



T TILESTYL **S** STARSTYL

I PANNELLI PER SOFFITTI
ED I CONTROSOFFITTI

TILES FOR CEILINGS
AND FALSE CEILINGS

I ITALSTYL **E** EUROSTYL **X** EXTRASTYL
C CLASSICSTYL **A** AMERICANSTYL

LE CORNICI, I ROSONI, LE TRAVI,
GLI ANGOLI ED I FREGI

IN POLISTIRENE ESTRUSO, ESPANSO, POLIMERI ESPANSI,
POLIURETANO E "POLISTRUTTURATO"

MOULDINGS, CEILING CENTRES, BEAMS,
CORNER BLOCKS AND DECORS

EXTRUDED AND EXPANDED PS, EXPANDED POLYMERS,
POLYURETHANE AND "POLISTRUTTURATO"



Le caratteristiche tecniche indicate nel presente catalogo vengono fornite a titolo indicativo e potranno essere modificate senza preavviso. Non devono quindi essere considerate a scopo di specifica.
The given values are indicative and can be changed without notice. They cannot be considered like a state.

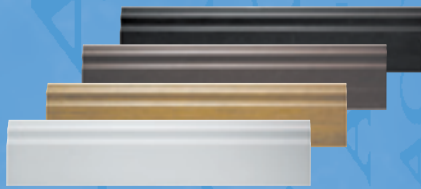

P PROFILSTYL
I PROFILI PER LA CASA
TRIMMINGS



B BRICKSTYL
PROFILI PER L'ESTERNO
EXTERIOR MOULDINGS



O OBJECTSTYL
L'OGGETTISTICA
PATCHWORK OBJECTS



E EUROSTYL
LE COLONNE
COLUMNS



W WOODSTYL
LE TRAVI IN POLIURETANO
POLYURETHANE BEAMS



I MANICHINI
MANNEQUINS

K KRISTALSTYL
OGGETTI TRASPARENTI
TRANSPARENT OBJECTS

This leaflet and the designs embodied within are protected by copyright law and international treaties. Unauthorized reproduction of the leaflet or any portion of it or reproduction of any of the designs embodied therein may result in severe civil penalties and will be prosecuted to the maximum. All rights reserved, Bovelacci Forlì Italy.

BOVELACCI



BOVELACCI

per carico merci:
Bovelacci Cargo - Via Fiume Ronco, 2
I-47122 Forlì - ITALY

Via del Commercio, 5
I-47122 Forlì - ITALY
Tel. +39 0543 811611
Fax +39 0543 721127

www.bovelacci.it - bovelacci@bovelacci.it

I.P. Ufficio Marketing Bovelacci